

REV	ECN #	DESCRIPTION	DRAWING	APPROVED	DATE
A		NEW RELEASE	DEV1		2015/02/03

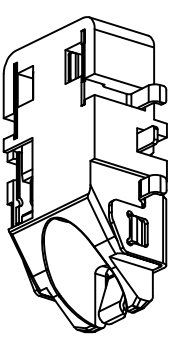
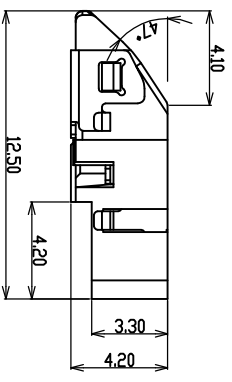
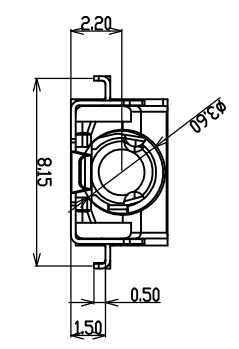
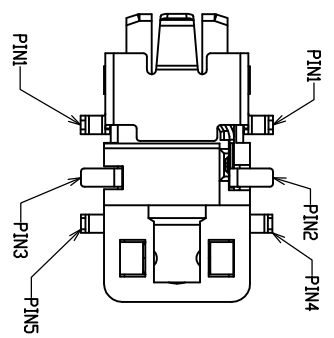
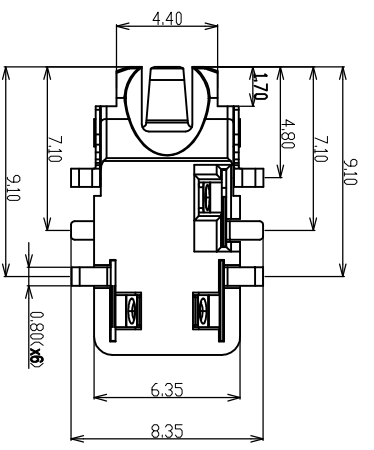

- NOTES :
- 1.0) RATING :
- VOLTAGE : 12 VDC (R.M.S.)
 - CURRENT : 1 AMPERE MAXIMUM PER CONTACT AT 30°C T-RISE
 - TEMPERATURE : -25°C TO +85°C
- 2.0) ELECTRICAL CHARACTERISTIC
- CONTACT RESISTANCE : INITIAL 50mΩ MAX. AFTER 100m
 - INSULATION RESISTANCE : 100 MΩ MIN.
 - DIELECTIC WITHSTANDING VOLTAGE : 500 VAC AT SEA LEVEL
- 3.0) MECHANICAL :
- DURABILITY : MINIMUM: MATED 5000 CYCLES WITHOUT DEGRADING ELECTRICAL
 - INITIAL:MATING FORCE: 300g~2000g, UNMATING FORCE: 300g~2000g
 - AFTER LIFE TESTING:MATING FORCE: 300g~2000g, UNMATING FORCE: 300g~2000g

PRODUCT NO.

PJ32-06 A B 03-01
① ② ③ ④

① PRODUCT SERIES:
PJ32: PHONE JACK CONNECTOR

② PIN NO. :
06: 6PIN

③ MATERIAL:
A: PA-9T

④ SERIES NO. :
01:斜头前后插板, 正沉1.5mm

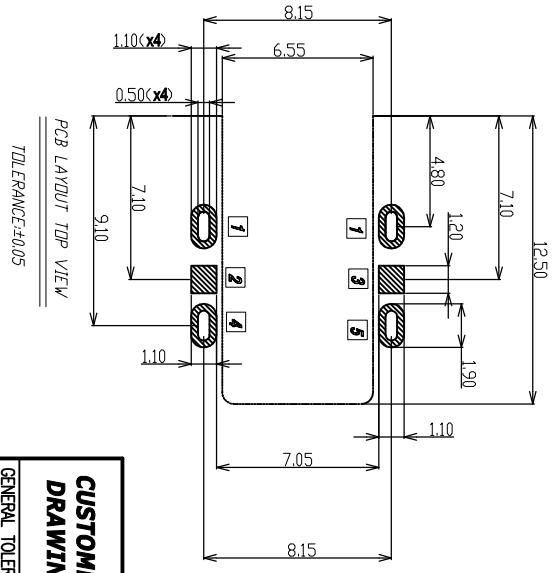
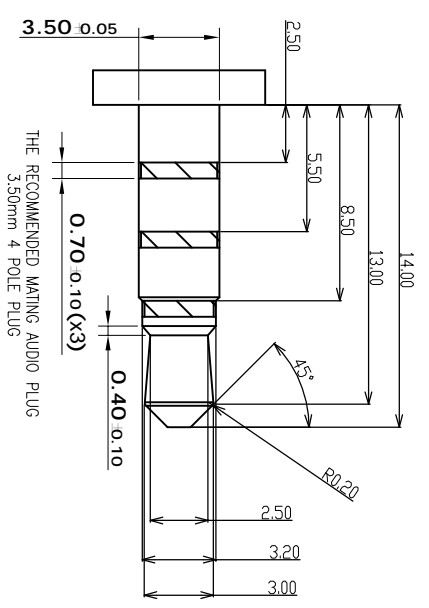

YTCOON
Dongguan YTCOON
Electronics Technology Co., Ltd

CUSTOMER DRAWING

GENERAL TOLERANCE

X ±0.20
.XX ±0.15
.XXX ±0.10

ANGEL TOLERANCE
X ±5°
.XX ±2°
.XXX ±1°

TITLE:
AUD10 JACK斜头前后插板, 正沉1.5mm

DRAWING NO.:
C-PJ32-01

DATE: 2015.02.03
DRAWING NO.: C-PJ32-01

UNIT	SCALE	SIZE	A4	SHEET	1of1	REV	A
mm	1:1	A4	SHEET	1of1	REV	A	